

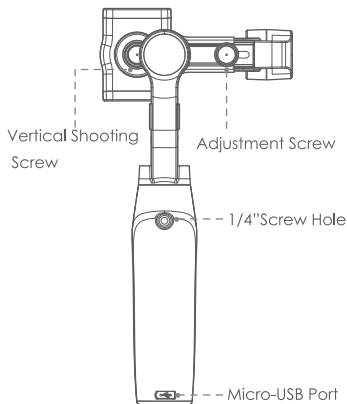

# QUICK START GUIDE

Mini-MI

## MOZA Mini-MI Overview

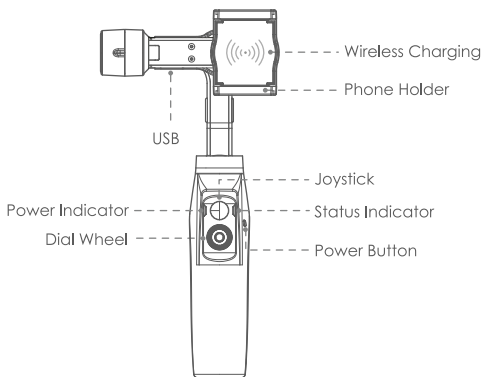

## Battery and Charging

The MOZA Mini-MI has a built-in lithium battery. Before the first use, fully charge it to activate the battery to ensure smooth operation. When the power indicator starts flashing, the battery level is less than 30%. Please charge it in time. With a universal Micro USB port, Mini-MI can be charged by both phone charger and power bank. The battery will automatically stop charging when it gets fully charged. Please disconnect the charger.

### Notes:

1. Please use the original charging cable provided in the package; Otherwise the Bluetooth will not be able to connect!
2. Do not overcharge or randomly discharge the battery; Otherwise the battery will be damaged!
3. If the battery is left unused for a long time, recharge and discharge it every 3 months to keep it active.

## Phone Mounting

Stretch the holder and place your phone into it, following the directions as shown on image A

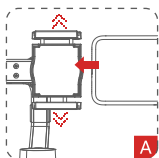

## Vertical Shooting Mode

Loosen the knob screw on the back of the holder, pull the holder out 5mm, rotate the holder clockwise 90°, and then tighten the screw.

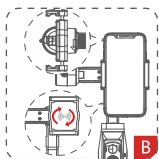

## Balance Adjustment

If the phone can't keep level, you can loosen the adjustment screw on the roll arm, then adjust the length of the arm to achieve balance

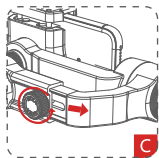

## Starting Up

- ON/OFF Button
- Long press: on/off
- Single press: standby/wake up

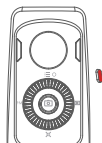

## Battery Level Viewing

Power indicator

- Steady blue light for upper and lower indicators: 70%-100% battery level
- Steady blue light for lower indicator: 30%-70%
- Flashing blue light: 0-30%
- Steady red light: charging

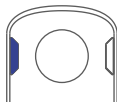

## Phone Charging

- Wireless Charging  
Double press the power button to start or stop wireless charging. When the battery level is less than 20%, wireless charging will automatically shut to ensure the smooth use of the gimbal.
- General Charging  
There is a USB port in the pitch arm, smartphone can be charged by a USB cable.



## Joystick

- Move the joystick upwards/downwards/leftwards/rightwards to control the movement of phone camera. Rotating speed depends how fast you move the joystick.

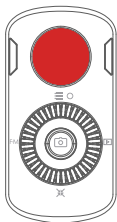

## Follow Modes

### Status Indicator

- Upper light is on: pitch follow
- Upper light is off: pitch lock
- Lower light is on: yaw follow
- Lower light is off: yaw lock

### Left button of the dial wheel

- Double press: pitch lock/follow
- Triple press: yaw lock/follow
- Long press: roll follow

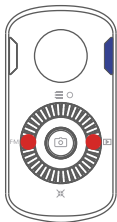

## Quick Operation

### Lower button of the dial wheel

- Double press: re-center (back to the starting point)
- Triple: selfie (phone's rear camera facing to the operator)

### Upper button

- Triple press the upper button to switch to the Inception Mode. (Then move the joystick leftwards or rightwards to rotate the phone)

### Right button

- Double press the right button to switch to the Sport Gear Mode (In Sport Gear Mode, the speed of yaw follow is very fast)

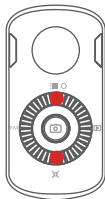

## Download APP

You can directly scan the QR code to download the "MOZA Genie" ( Android 5.0 or above, IOs 9.0 or above ), or you can directly search the "MOZA Genie" in the App store to download it. (please see app download QR code at the end of the page.)







1. The app "MOZA Genie" customized for MOZA Mini-MI can help you make better use of the various functions of the gimbal.
2. Please take the latest version of app as the standard. Updates are not subject to notice.

## Device Connection

1. Turn on the gimbal power supply
2. Turn on the Bluetooth;
3. Open the MOZA Genie app, select the gimbal you want to connect to, and automatically enter the shooting interface after the connection is successful.

## Camera Interface

	Single press the center button: start/stop recording (only valid in video mode)
	Double press the center: take photo Also valid during the video recording
	Single press: wake up the menu; Double press: switch video mode & photo mode
	Long press: switch front camera & rear camera
	Single press: quick playback Single press again to return to the camera
	Single press: zoom in/out automatically Single press again to go back to the original focal length
	ZOOM IN ZOOM OUT

## App Main Features

1. Recording control
2. Object tracking
3. Timelapse
4. Panorama
5. Camera setting
6. Focus and zoom control
7. Gimbal setting
8. Calibration

## Function Menu

- Rotate the dial wheel or single press the upper/down button to select an item

- Single press the left button to enter the next step
- Single press the right button to return to the previous step

## Professional Mode

After entering the function menu and selecting "professional mode",  the camera parameter setting icon will appear on the boundary surface. The camera shutter, iso, focus mode, exposure compensation, white balance and other parameters can be set, and the parameters can be adjusted by turning the dial wheel. Select the manual focus mode and turn the dial wheel to focus. After pushing out the menu, the dial wheel can no longer focus.

## Firmware Upgrade

Firmware upgrade: please scan the QR code at the end of the page for details to watch the tutorial.

## Calibration

The gimbal should be calibrated in the following situations:

1. Abnormal operation of the gimbal
2. After the gimbal is started, the horizontal angle is deviated again, which cannot be solved after one key is returned to the center.
3. Deviation caused by excessive temperature difference in operating environment of the gimbal

Calibration

For details, please scan the QR code at the end of the page to watch the tutorial.

## Warning And Disclaimer

Thank you for purchasing MOZA Mini-MI. Please read this article carefully before using the product. The content mentioned in this article concerns your safety, legal rights and responsibilities.

1. MOZA Mini-MI is the precision instrument and should be used carefully. Please read the <Mini-MI Quick Start Guide> before using it. Uncertain operation will lead to product damage, property damage and even personal injury.
2. This product is not suitable for children.
3. Do not use MOZA Mini-MI with products other than those recommended by MOZA.
4. Our company is responsible for the warranty and maintenance of the product's own problems, but because the user does not refer to this instruction, our company is not responsible for any direct or indirect losses caused by incorrect operation.
5. This product carries out after-sales return, replacement and maintenance services in accordance with the "three guarantees" policy. Our company does not assume any responsibility for any product failure caused by the user's destructive disassembly and modification without permission.
6. All program codes of this product have software copyright. Users are prohibited from cracking our products in any way and from obtaining, copying, modifying and disseminating program codes related to this product in any way. Otherwise, all legal consequences arising therefrom shall be borne by the users. Our company will investigate the legal liabilities of users according to law.
7. In the process of compiling this manual, we have tried our best to ensure the correctness and completeness of the content, but there are still inevitable mistakes and omissions. Please take the actual product as the standard.
8. The hardware, software, accessories and instructions of this product are subject to any changes without notice. Please visit the official website for the latest version at [www.gudsen.com](http://www.gudsen.com)

SPEC	
Max Payload	300g
Wireless Charging	5Woutput
Gimbal Weight	543g
Gimbal Dimension	143*107*290(W*D*H)
Phone Dimension	61 to 92 mm
Battery Life (hrs)	10-Hour
Charging Time	3.5-Hour
Mechanical Axis Angle	Yaw axis: $\pm 360^{\circ}$
	Roll axis: $310^{\circ}$
	Tilt axis: $\pm 165^{\circ}$